

ZHUART®

ZHUART®



Official website

Thermo Bamboo | Sustainable & Durable Bamboo
Solutions for Modern Outdoors

www.zhuartbamboo.com



Durable, Sustainable, and Elegant

ZHUART

BAMBOO

A SUSTAINABLE MARVEL

Bamboo is a fast-growing woody grass that matures in just 4-6 years, with daily growth rates of up to one meter. It is one of the most efficient carbon sinks, absorbing significantly more CO₂ during its growth than is emitted during processing.

Unlike hardwoods, bamboo regenerates naturally after harvesting and requires no replanting. Hardwoods, by contrast, take decades to regrow and are becoming increasingly scarce. Bamboo's rapid growth and renewability make it an exceptional alternative for protecting the planet's forests.

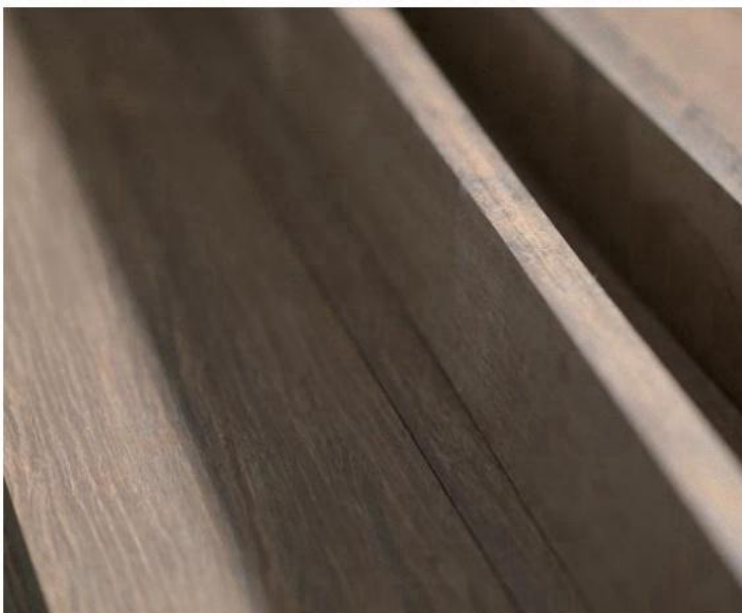

Bamboo Technical Features

Density	Tensile Strength	Compressive Strength	Bending Strength
0.7±	1855	525	1408
g/cm ³	kg/cm ²	kg/cm ²	kg/cm ²

Bamboo's exceptional technical features surpass those of most hardwoods, making it the ideal substitute for increasingly scarce tropical hardwoods.

Its distinct characteristics include natural beauty, straight grain patterns, and unique design aesthetics, offering a sophisticated and versatile solution for modern applications.

ZHUART Bamboo is crafted from 4–6-year-old moso bamboo harvested from sustainably managed forests. It is a superior choice for eco-conscious design.



163,000 m²

ZHUART operates with 163,000 square meters of certified factory space and a team of over 500 employees, including 16 senior technicians.

2,000,000 m²

With an annual production capacity of 2 million square meters, ZHUART runs two production bases in Fujian and Zhejiang provinces.

Equipped with the world's most advanced thermo bamboo production lines and testing facilities, we ensure unmatched quality in every product.

COMPANY PROFILE

ZHUART is a global leader in the innovation and production of high-density thermo bamboo products. Established in 2010 and headquartered in Zhejiang, China, we operate state-of-the-art manufacturing facilities in Nanping, Fujian, and the Lishui Industrial Park in Zhejiang.

Certifications

ISO 9001: Quality Management System.

ISO 14001: Environmental Management System.

ISO 45001: Occupational Health and Safety Management.

FSC CoC: FSC 100% Chain of Custody Certification.

EPD: Environmental Product Declaration.

Awards and Recognitions

National High-Tech Enterprise in China.

Leading Agricultural Enterprise of Zhejiang Province; Leading Forestry Industry Enterprise of Fujian Province.

Winner of the Ministry of Education Science and Technology Progress Award (Second Class). The China Forestry Industry Innovation Award (Second Class) for the development of "Key Technologies for Bamboo Board."

R&D Leadership

Holder of 16 patents.

Core contributor to national and industry standards, including national standard for Carbonized Bamboo Boards and outdoor Thermo Bamboo standard.

Innovation Base of Engineered Bamboo Materials by the National Forestry and Grassland Administration.

Industrial-Academic-Research Base of the National Bamboo Industry Research Institute.



ISO 14001:2015



ISO 9001:2015



ISO 45001:2018



The mark of responsible forestry

FSC 100%



At ZHUART, we transform raw bamboo into Thermo Bamboo through a process of thermal modification and high-density compression.

Thermal Modification

Bamboo strands are heated to temperatures up to 200°C with steam to protect against charring. This process breaks down water-absorbing molecular chains, eliminates sugars that attract fungi and pests, and enhances the bamboo's durability while transforming its color into a rich, deep brown.

To achieve optimal moisture content and increase dimensional stability, the treated strands are carefully cooled, dipped in glue, and then re-dried. This non-toxic process strengthens bamboo without chemical preservatives, reducing swelling, shrinking, and warping during future use.

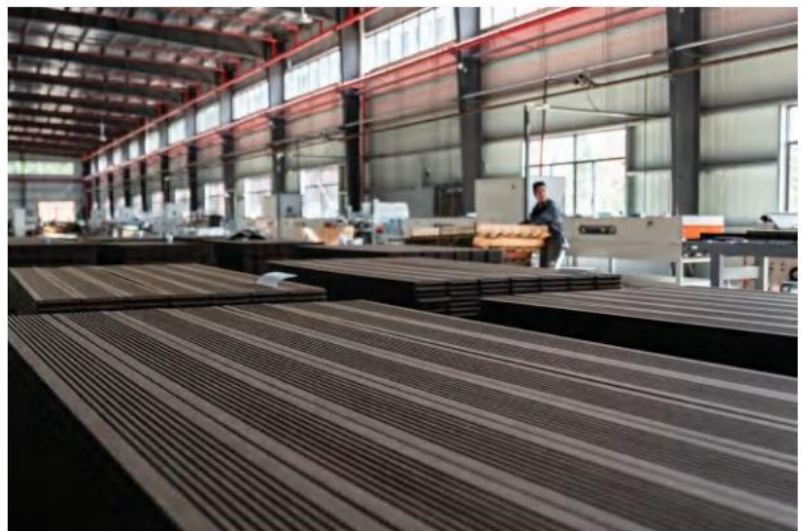



High-Density Compression

The modified bamboo strands are compressed under extreme pressure to form a solid, dense material. The result is a highly durable material suitable for outdoor environments.

THERMO BAMBOO FOR EXTERIOR USE

Outdoor materials face harsh conditions such as constant exposure to sunlight, rain, and varying temperatures. These environmental challenges, combined with growing demand for sustainability, have raised expectations for the performance and eco-friendliness of materials.

Common traditional outdoor materials include:



Hardwood

Global efforts to combat illegal logging and regulate timber trade have limited the availability of hardwoods, raising concerns about their long-term sustainability.



Pressure-Treated Wood

Treated with chemical preservatives, this material can leach harmful substances into the soil and water over time, leading to secondary environmental pollution.



Wood-Plastic Composites (WPC)

Made from synthetic materials like polyethylene and polypropylene, WPC lacks natural grain and aesthetic appeal of real wood. It is also prone to deformation and surface damage under long-term use.

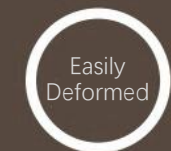



Thermo Bamboo

ZHUART Thermo Bamboo undergoes unique thermal modification, resulting in high density, superior durability, exceptional resistance to decay, and enhanced dimensional stability.

This innovative solution addresses common issues faced by other outdoor materials, such as cracking, deformation, and environmental concerns. It is widely used in outdoor decking, cladding, panels, wall grilles, and various other applications.



PRODUCT FEATURES



Sustainable & Eco-Friendly

Crafted from natural bamboo, ZHUART products are a renewable, sustainable, and healthy choice for modern construction.



Dimensional Stability

Compressed under 2400 tons of pressure and thermally modified, our products deliver high density, exceptional hardness, termite resistance, and outstanding dimensional stability.



Mold & Decay Resistance

Through thermal modification, natural nutrients within the bamboo are completely removed. This enhances material stability while providing superior mold and decay resistance.



Carbon Neutral

Bamboo is one of the most sustainable materials on Earth, absorbing significant amounts of CO₂ during its growth. With low emissions during production, our bamboo products contribute to carbon neutrality.



Natural Elegance

The restructured bamboo retains its unique, natural grain patterns, offering both aesthetic appeal and durability.



Low Maintenance

Easy to install and clean, ZHUART products require no painting, sealing, or additional staining, making them a hassle-free solution for outdoor and indoor use.

PRODUCT PERFORMANCE

No.	Property	Result	No.	Property	Result
1	Density	1.15-1.25 g/cm ³	6	VOC Emission	Class E1 (lowest emission class)
2	Corrosion Resistance	Class I (highest rating)	7	Modulus of Elasticity	≥10,000 MPa
3	Mold Resistance	Grade 0 (highest rating)	8	Modulus of Rupture	≥80 MPa
4	Fire Resistance	Class Bf1-s1	9	Swelling Rate (1h Boiling Test)	≤3%
5	Anti-Termite	Class 10 (highest rating)	10	Swelling Rate (24h in Water)	≤1%



Submerged in Water - ZHUART bamboo decking remains stable even when fully submerged in water.



After the Water Recedes - After prolonged exposure to water, ZHUART bamboo decking retains its integrity.



ZHUART bamboo decking by the riverside.





PRODUCT CATEGORY

Thermo Bamboo Decking

- ✓ Multiple sizes, custom dimensions available
- ✓ End-matched (optional), edge-grooved with hidden clip fasteners



Color: Deep Charcoal
Surface: Flat



Color: Charcoal
Surface: Flat



Color: Charcoal
Surface: Standard Groove



Color: Charcoal
Surface: V Groove



Color: Chestnut
Surface: Standard Groove



Color: Chestnut
Surface: V Groove



Color: Mahogany Red
Surface: Flat



Color: Golden Oak
Surface: Flat

Profile (mm)

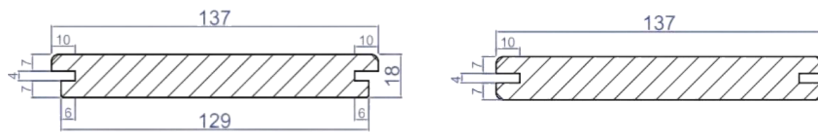

Standard Dimensions (mm)

137 Width	178 Width	65 Width
T18 * W137 * L1850/2000/2440	T18 * W178 * L1850/2000/2440	T18 * W65 * L1850/2000/2440
T20 * W137 * L1850/2000/2440	T20 * W178 * L1850/2000/2440	T20 * W65 * L1850/2000/2440
T30 * W137 * L1850/2000/2440	T30 * W178 * L1850/2000/2440	T30 * W65 * L1850/2000/2440
T40 * W137 * L1850/2000/2440	T40 * W178 * L1850/2000/2440	T40 * W65 * L1850/2000/2440
		T50 * W65 * L1850/2000/2440
		T60 * W65 * L1850/2000/2440

Thermo Bamboo Cladding

- ✓ Edge-grooved with hidden clip fasteners (optional)
- ✓ Custom dimensions and profiles available



Color: Deep Charcoal



Color: Chestnut



Color: Mahogany Red



Color: Golden Oak

Standard Dimensions (mm)

Edge-Grooved	No Grooves
T12 * W100 * L1860/2000/2440 T18 * W100 * L1860/2000/2440	T8 * W100 * L1860/2000/2440 T12 * W100 * L1860/2000/2440 T18 * W100 * L1860/2000/2440

Thermo Bamboo Panels

- ✓ Multiple sizes, custom dimensions available



Color: Deep Charcoal



Color: Chestnut



Color: Mahogany Red



Color: Golden Oak

Standard Dimensions (mm)

100 Width	65 Width
T20 * W100 * L1860/2000/2440 T30 * W100 * L1860/2000/2440 T40 * W100 * L1860/2000/2440 T50 * W100 * L1860/2000/2440 T60 * W100 * L1860/2000/2440	T20 * W65 * L1860/2000/2440 T30 * W65 * L1860/2000/2440 T40 * W65 * L1860/2000/2440 T50 * W65 * L1860/2000/2440 T60 * W65 * L1860/2000/2440

Thermo Bamboo Grad System

- ✓ Multiple sizes, custom dimensions available



Decking & Cladding
Color: Deep Charcoal
Surface: Curved



Decking & Cladding
Color: Charcoal
Surface: Curved



Panels
Color: Charcoal

Standard Dimensions (mm)

Grad Decking & Cladding	Grad Panels 65 Width	Grad Panels 45 Width
T21 * W119 * L1850/2000/2440	T20 * W65 * L1860/2000/2440	T20 * W45 * L1860/2000/2440
T21 * W155 * L1850/2000/2440	T30 * W65 * L1860/2000/2440	T30 * W45 * L1860/2000/2440
T30 * W119 * L1860/2000/2440	T40 * W65 * L1860/2000/2440	T40 * W45 * L1860/2000/2440
T30 * W155 * L1860/2000/2440	T50 * W65 * L1860/2000/2440	T50 * W45 * L1860/2000/2440
T40 * W119 * L1860/2000/2440	T60 * W65 * L1860/2000/2440	T60 * W45 * L1860/2000/2440
T40 * W155 * L1860/2000/2440		

Thermo Bamboo Handrail and Edge Strip

- ✓ Multiple sizes, custom dimensions available



Edge Strip
Color: Deep Charcoal



Round Handrail
Color: Charcoal



Round Handrail
Color: Chestnut



U Handrail
Color: Chestnut

Standard Dimensions (mm)

Edge Strip	Round Handrail	U Handrail
T18/28 * W65 * L1850/2000/2440	Φ30 * L1850/2200	T40 * W40 * L1860/2000/2440
T20/30 * W65 * L1850/2000/2440	Φ40 * L1850/2200	T50 * W50 * L1860/2000/2440
	Φ50 * L1850/2200	
	Φ60 * L1850/2200	

Customized Solutions

- ✓ Custom dimensions, shapes, and patterns
- ✓ Bespoke products
- ✓ Outdoor furniture and fixtures

We understand that every project is unique.

ZHUART Customized Solutions go beyond standard products to meet your specific needs. We provide 3D model design and tailored manufacturing to bring your ideas to life.

Outdoor Furniture Sample Products

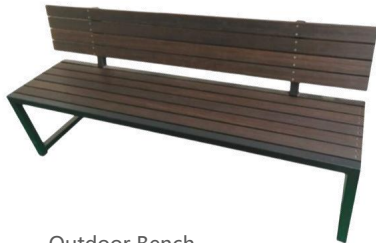

Outdoor Bench

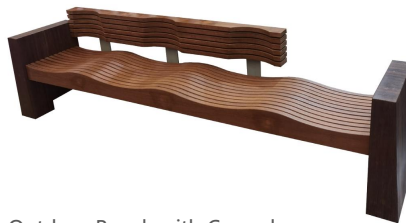

Outdoor Bench with Curved Surface



Outdoor Bench Featuring Curved Panels



Outdoor Railing

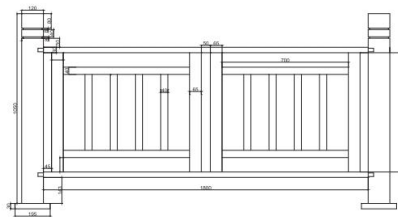

(A)

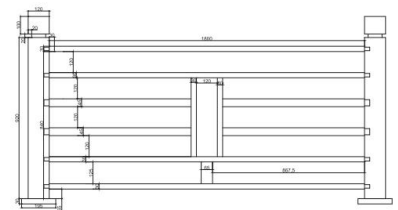

(B)

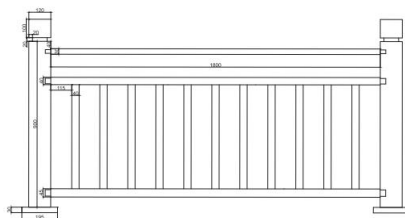

(C)

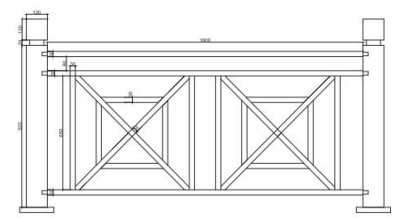

(D)

INSTALLATION GUIDE

Decking Installation

Before Installation

- ◆ Prepare ZHUART decking boards along with the necessary accessories, including stainless steel fasteners and screws.



L-fastener

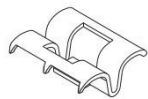

U-fastener

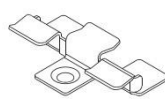

I-fastener



Flat decking (mm)

Substructure

- ◆ Use durable, rot-resistant materials such as galvanized steel for the joists.
- ◆ For decking boards with a length of 1850mm, space the joists at 462.5mm intervals (center to center). Ensure the ends of each decking board are properly supported on the joists.

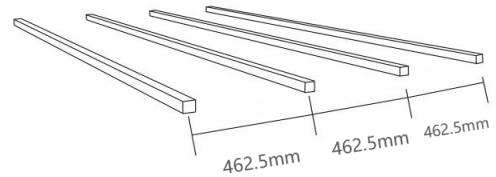

Installation Using Hidden Clip Fasteners

- ◆ Use an L-fastener to secure the outer edge of the first decking board to the joist. Tap the decking firmly into the clip fastener using a rubber mallet.
- ◆ Position a U-fastener (or I-fastener) into the edge groove of the installed decking board. Tighten the screw in the fastener to secure it to the joist.
- ◆ Slide the next decking board onto the exposed fastener. Use a rubber mallet to tap the board into place.
- ◆ Repeat for subsequent boards, maintaining a gap of 5-6mm between adjacent boards.
- ◆ For the closing board, use a one-sided grooved decking board. Pre-drill holes on the surface and secure it to the joist with screws.

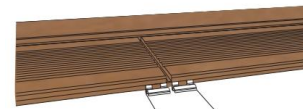
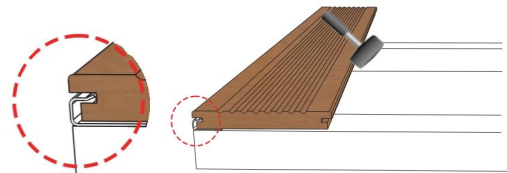

Option 1



Option 2



Note: This guide is for reference purposes only. Follow specific construction requirements and local building codes as applicable.

Cladding Installation

Before Installation

- ◆ Prepare ZHUART decking boards along with the necessary accessories, including stainless steel fasteners and screws.

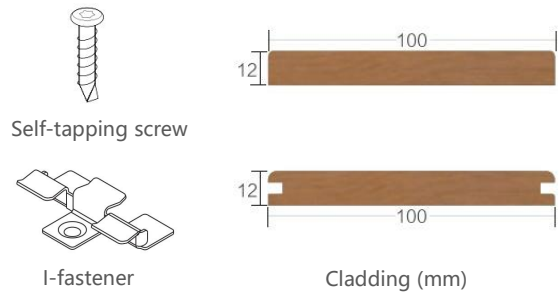

Substructure

- ◆ Use durable materials for the joists.
- ◆ For cladding boards with a length of 1860mm, space the joists at 465mm intervals (center to center). Ensure the ends of each cladding board are positioned on the joists.

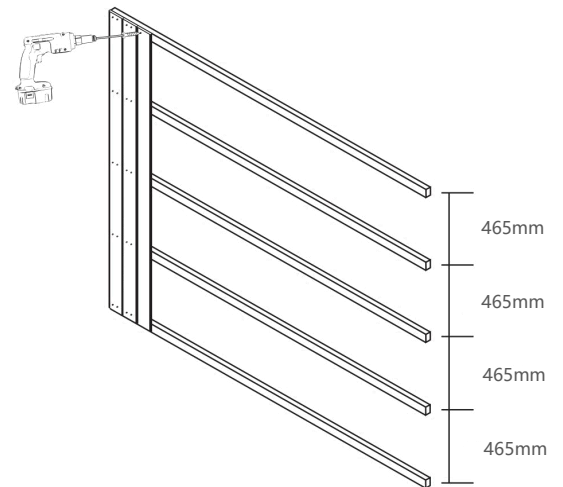

Installation Using Screws

- ◆ Pre-drill holes into the cladding boards. Secure the boards directly to the joists using screws.

Installation Using Hidden Clip Fasteners

- ◆ Insert an I-fastener into the edge groove of the cladding board. Tighten the screw in the fastener to secure it to the joist.
- ◆ Press the next cladding board into place over the exposed fastener.
- ◆ Repeat this process for the remaining boards. Leave a gap of approximately 2mm between adjacent boards.
- ◆ For the closing board, use a one-sided grooved cladding board. Pre-drill holes on the surface and secure it to the joist with screws.

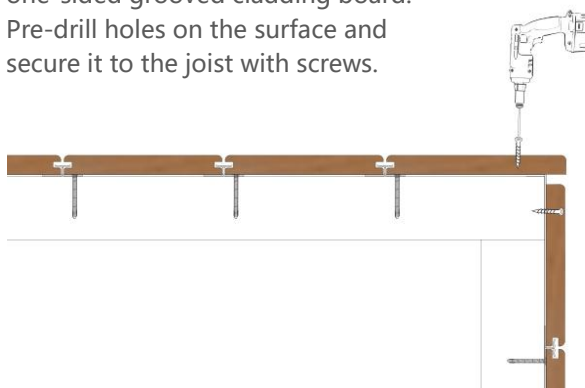
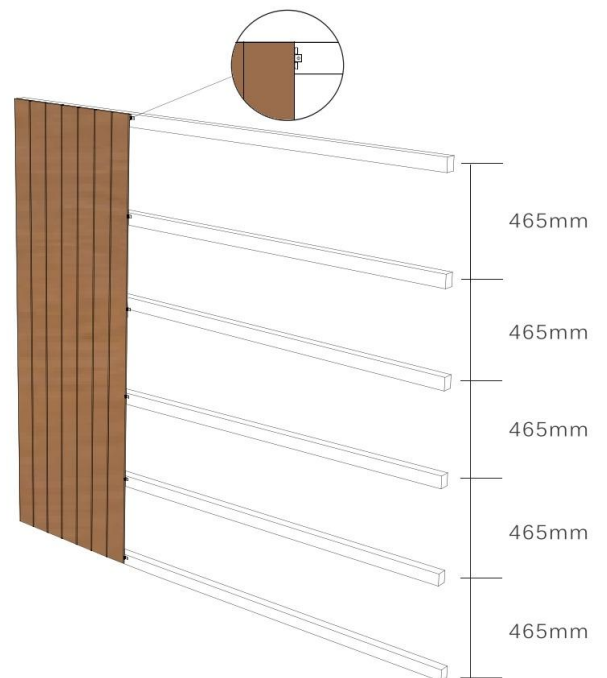

Note: This guide is for reference purposes only. Follow specific construction requirements and local building codes as applicable.

Panel Installation

Before Installation

- ◆ Prepare ZHUART panels and necessary accessories, including stainless steel U-brackets, bolts and nuts.

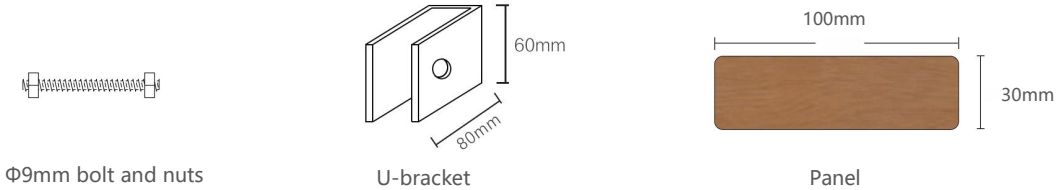

Substructure

- ◆ Use durable materials such as galvanized steel, aluminum, or stainless steel for the joists.
- ◆ For panels measuring 1860mm in length, space the joists at 465mm intervals (center to center). Ensure the ends of each panel are positioned on the joists.

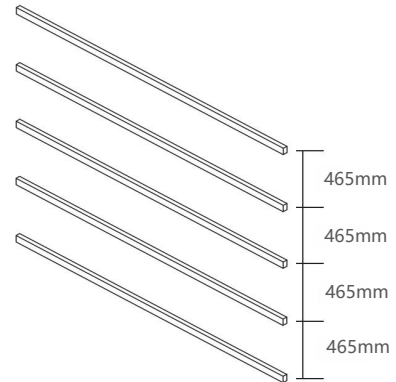

Installation Using Screws

- ◆ Pre-drill holes into the panels. Secure each panel to the U-bracket using bolts and nuts.
- ◆ Weld the U-bracket to the joist using full-welded links.

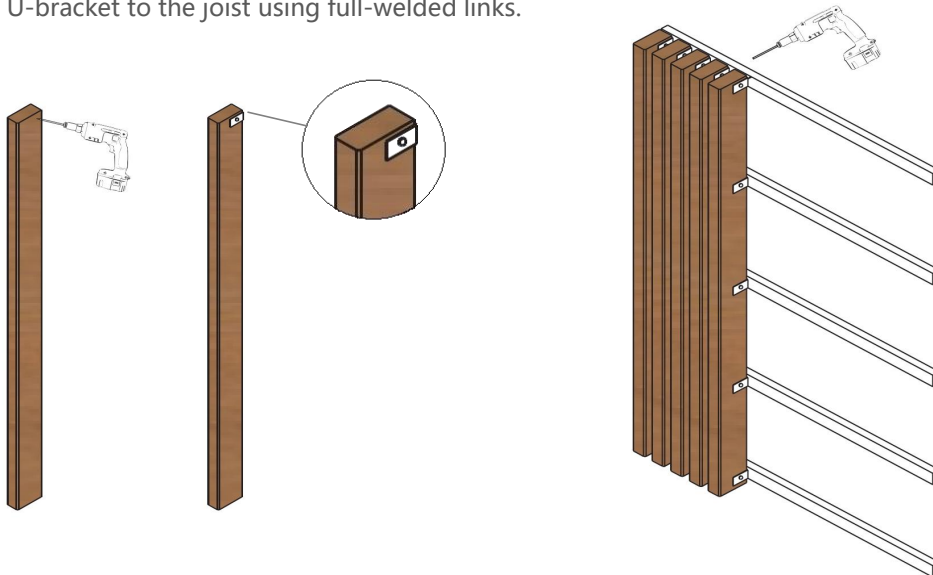

Note: This guide is for reference purposes only. Follow specific construction requirements and local building codes as applicable.

MAINTENANCE GUIDE



After installation



After two years

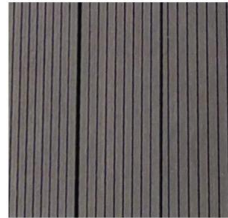

Re-oiled

General Maintenance Recommendations

- ◆ Annual maintenance is recommended, though the frequency may vary depending on the climate and usage conditions.
- ◆ For best results, use water-based oil or WOCA exterior oil for outdoor bamboo products.
- ◆ The ideal time for the first maintenance is 3-6 months after installation.
- ◆ Regular sweeping is recommended to keep the decking free of dust and dirt.

Maintenance Instructions

- ◆ Step 1: Remove dust, sand, and debris from the surface of the decking. For thorough cleaning, use clean water and a soft brush. Avoid harsh chemicals or abrasive tools.
- ◆ Step 2: Ensure the decking is completely dry before proceeding to the next step.
- ◆ Step 3: Apply 1-2 coats of WOCA exterior oil or water-based outdoor oil. Use approximately 30-50 grams per square meter.

Pro Tips for Longevity

- ◆ Natural Aging: Without annual oiling, the decking will develop a silver-grey patina over time.
- ◆ Stain Removal: Address spills promptly with mild detergent and water.
- ◆ Drainage: Ensure proper drainage to prevent water accumulation, especially in wet conditions.
- ◆ Avoid: Strong acids, alkalis, or pressure washers.

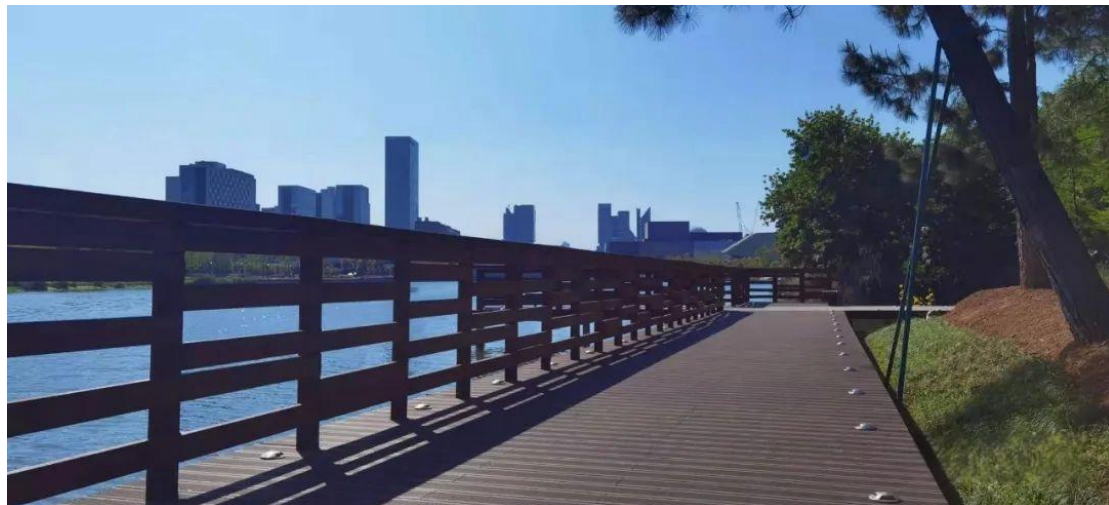
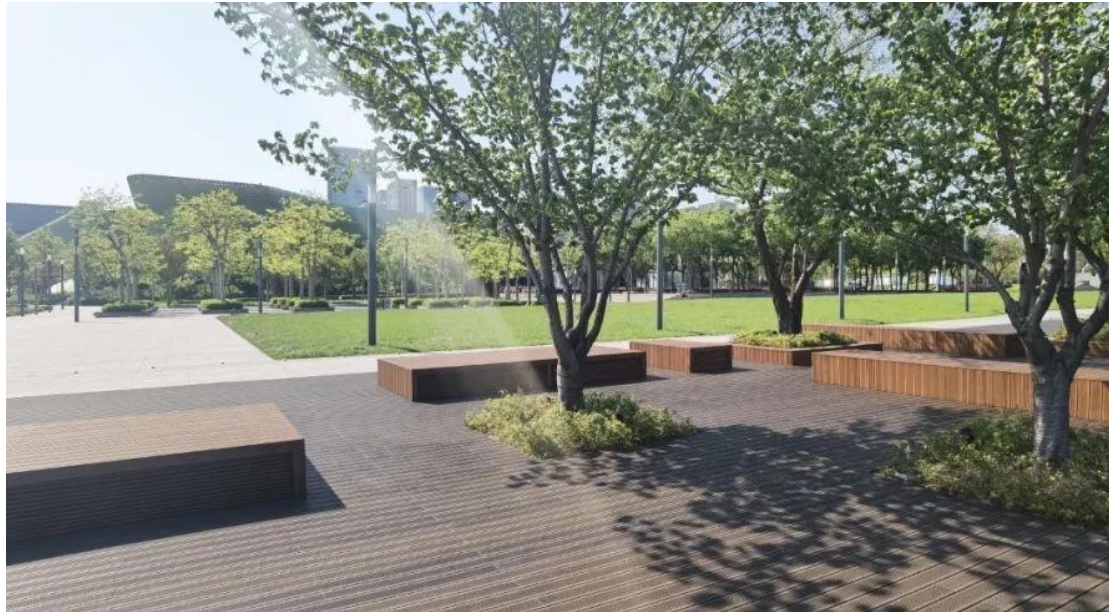

NINGBO CIVIC SQUARE

NINGBO, CHINA

Located south of Ningbo City Hall, Ningbo Civic Square integrates water, greenery, and walkways around the scenic 170-meter-wide Houtang River.

Product: Standard Groove Bamboo Decking
Area Installed: 1,500 m²

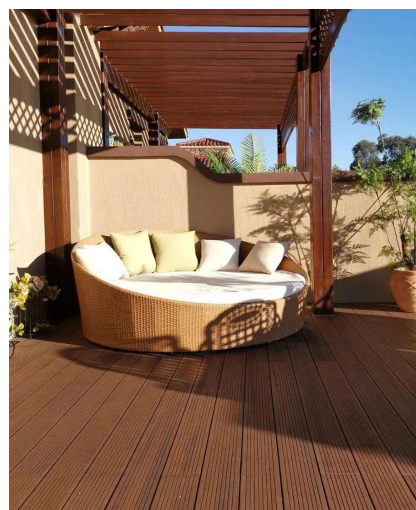
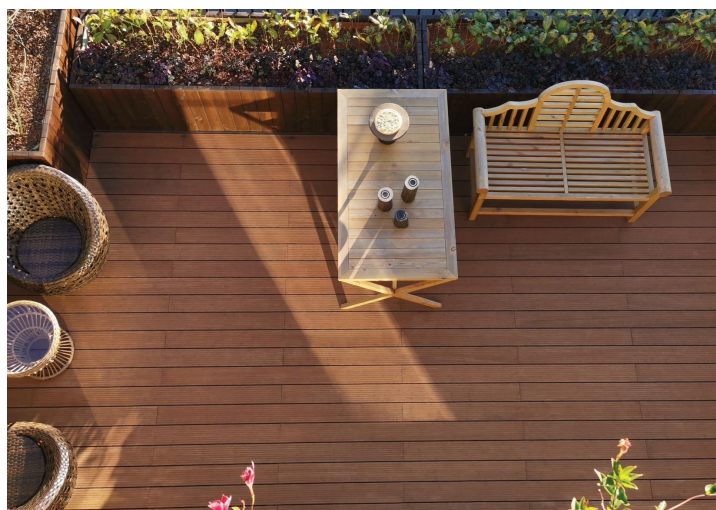
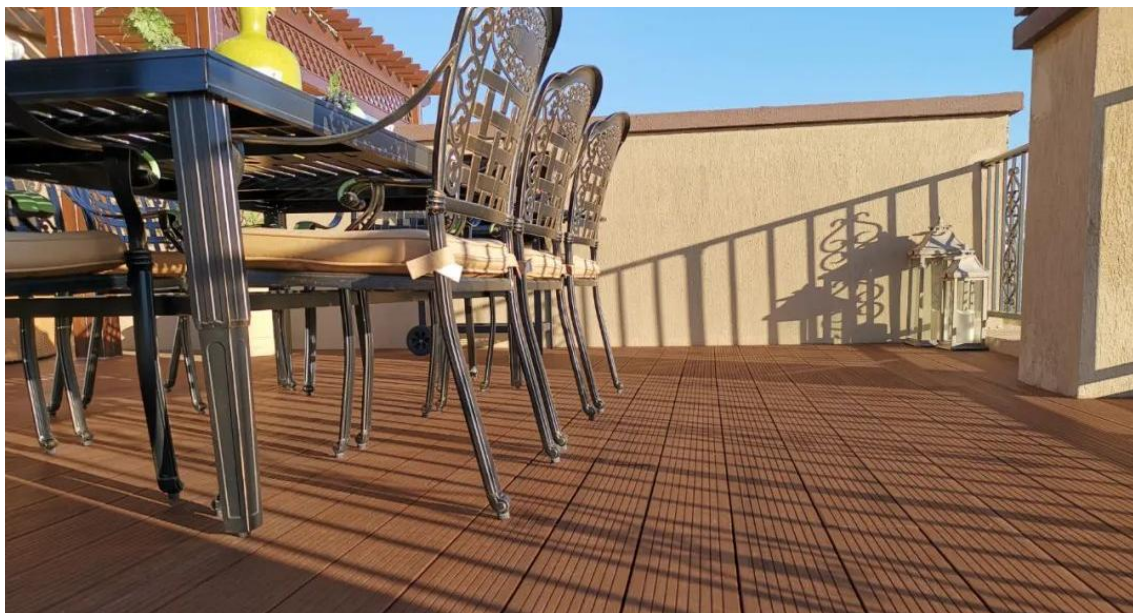

YULONG VILLA

KUNMING, CHINA

Nestled in Kunming's lush greenery and year-round spring-like climate, Yulong Villa uses chestnut brown ZHUART bamboo decking to blend seamlessly with its natural surroundings, embodying comfort, eco-friendliness, and serenity.

Product: V Groove Bamboo Decking

Area Installed: 2,000 m²



ANTAI PLAZA

RIZHAO, CHINA

The combination of ZHUART bamboo decking and surrounding furniture creates a relaxed ambiance. Over time, the decking's natural weathering reveals its authentic tones, harmonizing with the adjacent blue pool to provide a tranquil yet refined retreat.

Product: Standard Groove Bamboo Decking
Area Installed: 550 m²





FLC VILLA

QUANG NINH, VIETNAM

Nestled in the lush, tropical environment of Ha Long City, the FLC villa integrates luxury and sustainability. The poolside decking is crafted from ZHUART Bamboo materials, providing durability, elegance, and an environmentally conscious touch to the outdoor living space.

Product: Flat Bamboo Decking

Area Installed: 260 m²



SHERATON RIZHAO HOTEL

RIZHAO, CHINA

Located in the scenic Wapingkou coastal area, this ocean-facing hotel is a stunning collaboration between Marriott International and Xingye Group, built to five-star international standards. ZHUART bamboo decking, paired with marble, creates a warm and inviting outdoor environment.

Product: Standard Groove Bamboo Decking
Area Installed: 2,000 m²



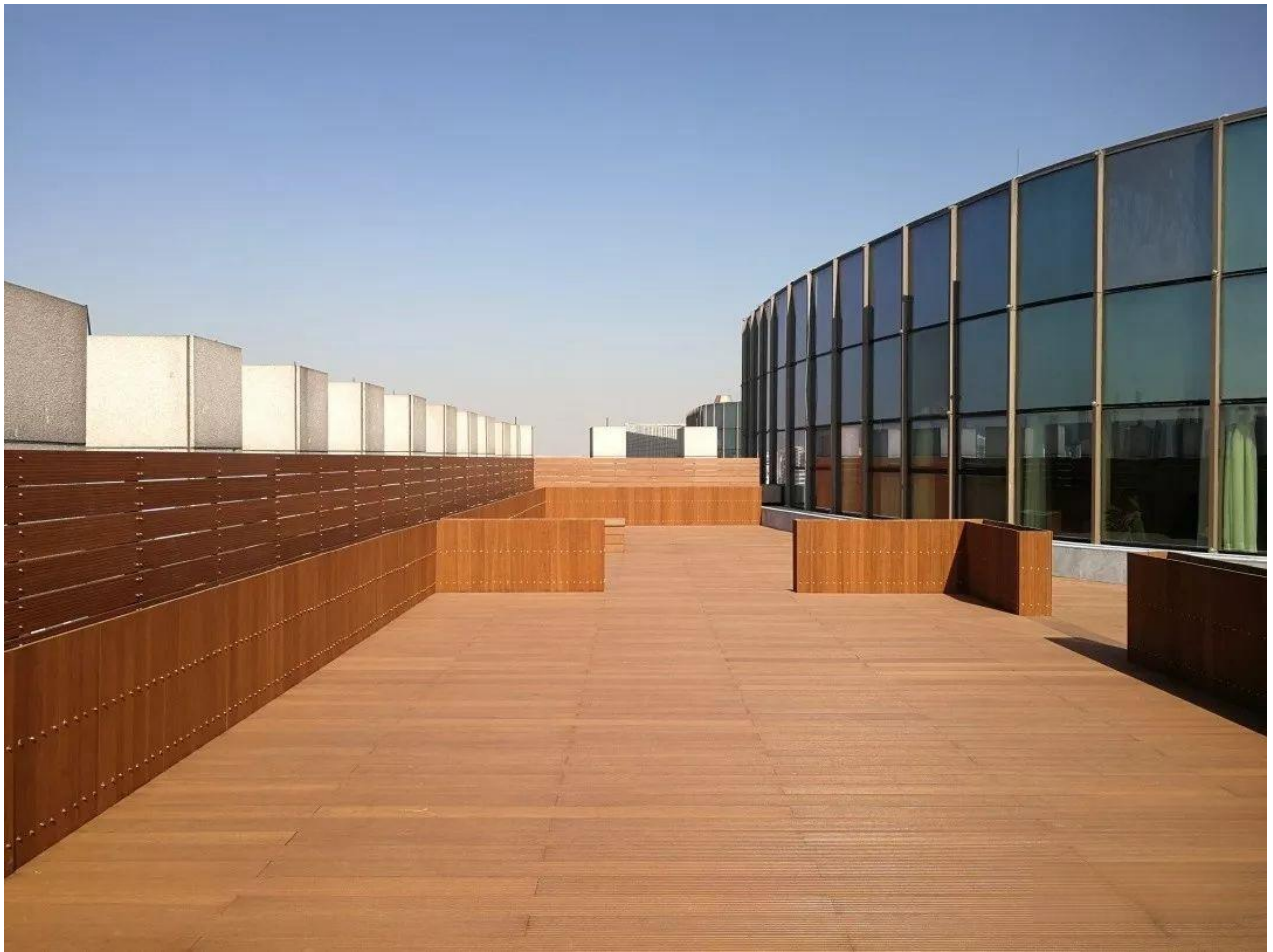

TECHNOLOGY INNOVATION CENTER

SHANXI, CHINA

Located in the Shanxi Comprehensive Reform Demonstration Zone, this project incorporates ZHUART bamboo materials for its flooring and wall cladding. The elegant, fresh color scheme and minimalist design echo the center's theme of "embracing a new era."

Product: V Groove Bamboo Decking

Area Installed: 1,300 m²



SOUTHWEST MINZU UNIVERSITY

SICHUAN, CHINA

This project at Southwest Minzu University illustrates the harmony of bamboo with natural and architectural elements, creating a space that is both functional and inspiring.

Product: Standard Groove Bamboo Decking
Area Installed: 2,000 m²



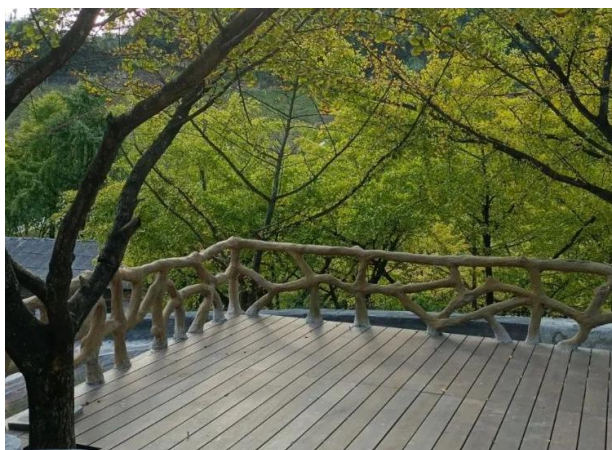
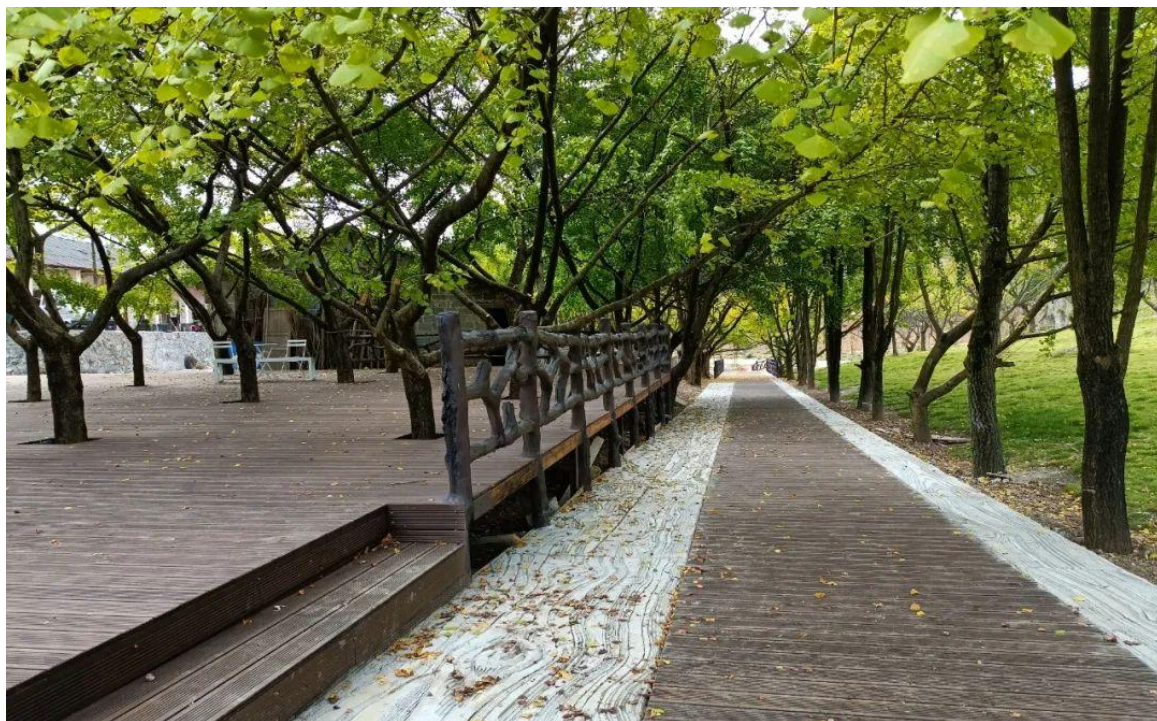

MAPLE & GINKGO ECOTOURISM SCENIC AREA

GUANGXI, CHINA

To complement the scenic area's eco-conscious philosophy, the pathways are built using ZHUART bamboo decking. The bamboo decking embodies sustainability while offering durability and aesthetic appeal, perfectly aligning with the park's vision of natural integration.

Product: Standard Groove Bamboo Decking
Area Installed: 15,000 m²

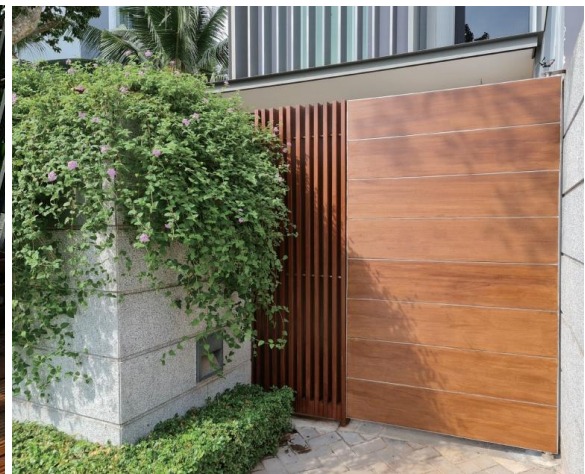
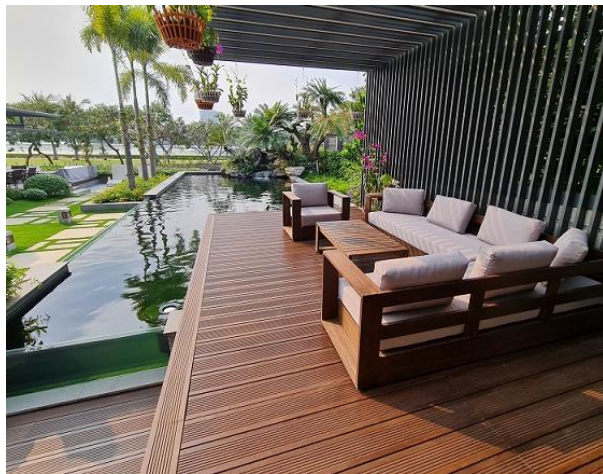

HOLM THAO DIEN VILLA

THAO DIEN, VIETNAM

Nestled in Thao Dien, Vietnam, the Holm Thao Dien Villa embraces the region's natural beauty and tropical climate. Featuring ZHUART bamboo decking and panels, the villa's courtyards and pathways create a retreat where residents can connect with nature in comfort and style.

Product: Standard Groove Bamboo Decking and Bamboo Panels
Area Installed: 160 m²



DAJING MUSHANG HOTEL

YUNNAN, CHINA

Located at the foothills of lush forests in an exclusive golf resort, the hotel in Tengchong, Yunnan provides a retreat immersed in nature. ZHUART's chestnut bamboo materials enrich the hotel's design, creating a harmony with the verdant surroundings.

Product: Bamboo Panels, Cladding, and Handrails
Area Installed: 2,120 m²





REVIVAL PAVILION

SHANGHAI, CHINA

Inspired by traditional Chinese paper-cutting and origami, Revival Pavilion seamlessly merges cultural heritage with modern design. It is China's first exhibition hall to achieve WELL Gold Certification, prioritizing occupant health and comfort.

Product: Bamboo Cladding
Area Installed: 11,000 m²

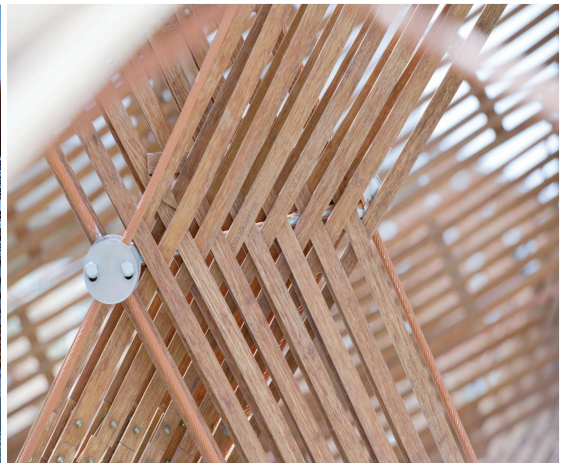

BAMBOO AND RATTAN PAVILION

SHANGHAI, CHINA

Designed for the China Flower Expo, the Bamboo and Rattan Pavilion resembles a delicate bamboo weave. To achieve the lightweight yet robust structure, ZHUART customized bamboo panels were used, offering the required flexibility and strength for the intricate design.

Product: Customized Bamboo Panels
Area Installed: 3,000 m²

WUXI CANAL PARK

WUXI, CHINA

Situated along the Wuxi section of the Grand Canal, this cultural park is the largest of its kind in the city. ZHUART bamboo materials are featured in the riverside boardwalks and functional areas, blending seamlessly with the surrounding landscape.

Product: V Groove Bamboo Decking,
Customized Railings, and Furniture
Area Installed: 1,600 m²





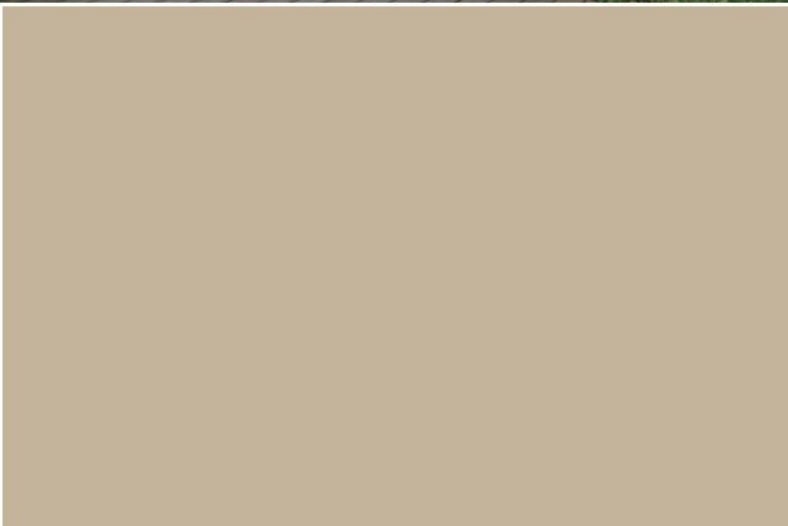



ZHUART

39

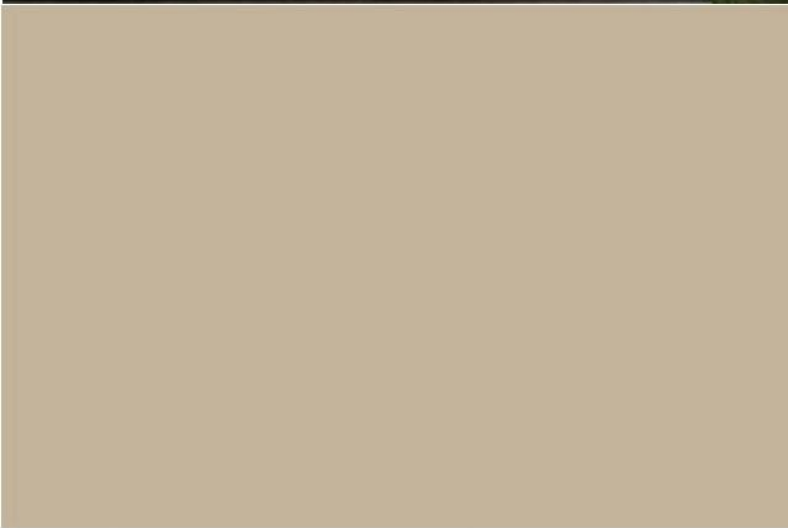
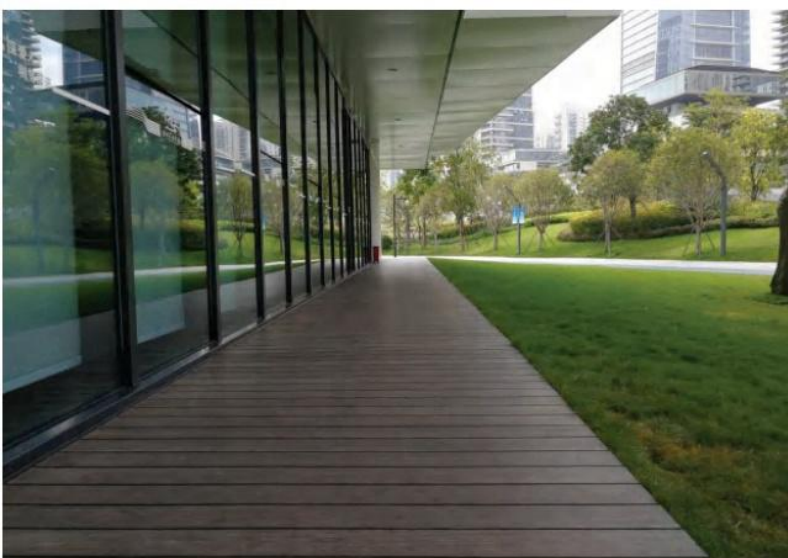



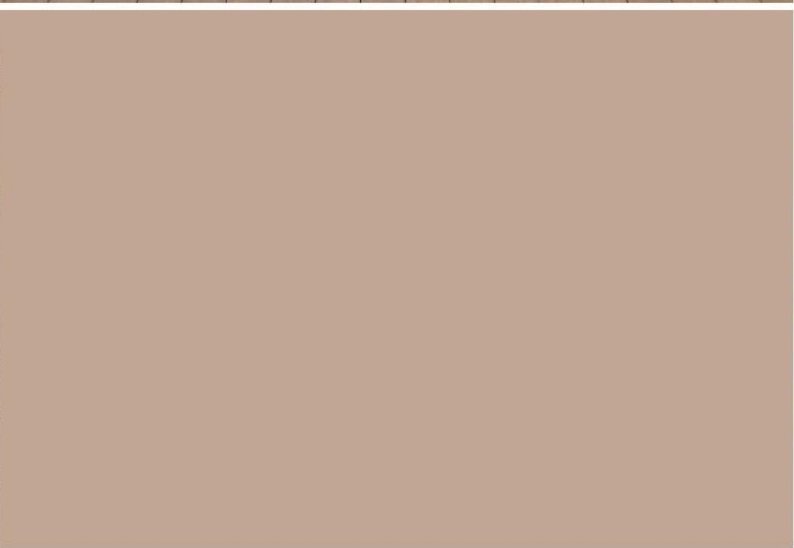

ZHUART®

Zhejiang ZAHO Bamboo Technology Co., Ltd

1916 Jiangling Road, Binjiang District

Hangzhou, Zhejiang, China

info@zhuartbamboo.com

www.zhuartbamboo.com